

SECTION A-A

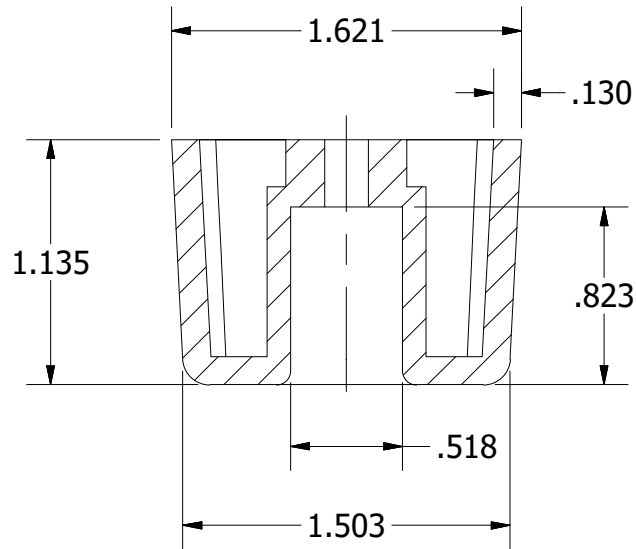

				UNLESS OTHERWISE SPECIFIED	DRAWN	2/17/2016		BUDWIG COMPANY, INC.		
				DIMENSIONS ARE IN INCHES TOLERANCE: ±.010	CHECKED					
				MATERIAL:	MFG	TITLE F-068-				
				Monsanto Santoprene Thermoplastic Rubber	APPROVED					
REV.	DESCRIPTION	DATE	APPROVED	REVISIONS				SIZE A	DWG NO F-068-	REV A
<p>PROPRIETARY AND CONFIDENTIAL THE INFORMATION CONTAINED IN THIS DRAWING IS THE SOLE PROPERTY OF BUDWIG COMPANY, INC. ANY REPRODUCTION IN PART OR AS A WHOLE WITHOUT THE WRITTEN PERMISSION OF BUDWIG COMPANY, INC. IS PROHIBITED.</p>				COMMENTS:				SCALE	SHEET 1 OF 1	