

SECTION A-A

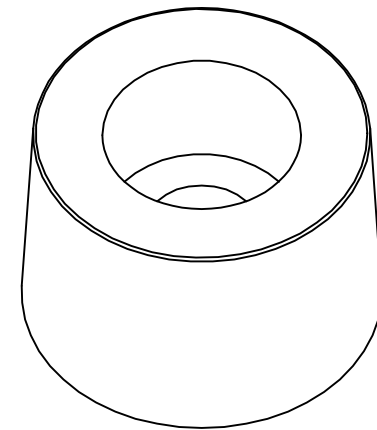
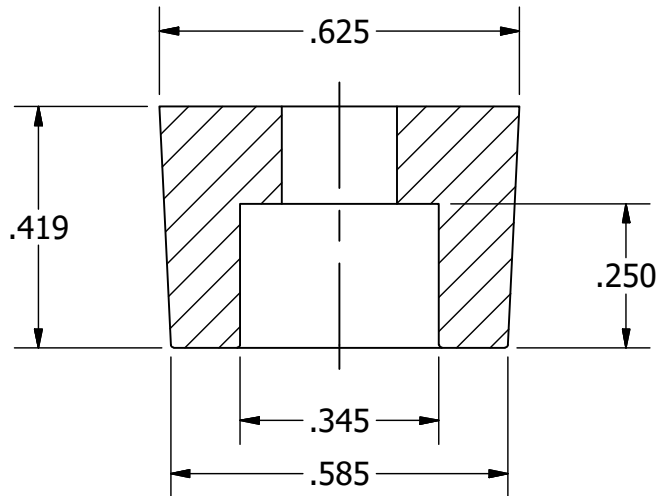

				DRAWN	2/17/2016	BUDWIG COMPANY, INC.		
				CHECKED				
				MATERIAL: Monsanto Santoprene Thermoplastic Rubber	MFG	TITLE F-075-		
REV.	DESCRIPTION	DATE	APPROVED	APPROVED				
REVISIONS				COMMENTS:		SIZE A	DWG NO F-075-	REV
PROPRIETARY AND CONFIDENTIAL THE INFORMATION CONTAINED IN THIS DRAWING IS THE SOLE PROPERTY OF BUDWIG COMPANY, INC. ANY REPRODUCTION IN PART OR AS A WHOLE WITHOUT THE WRITTEN PERMISSION OF BUDWIG COMPANY, INC. IS PROHIBITED.						SCALE		SHEET 1 OF 1